





Auto Urinal Flusher (Recessed Series) HC-AUF419



-  Touch-Free IR Activation
-  Stylish SS Plated Design
-  Intelligent Sensing
-  Low Maintenance
-  Water Saving

DESCRIPTION

Operation	Infrared Sensor (Pre & Post Flush)
Power Supply	Battery: 6V DC (4 x AA Alkaline) Electrical: 220V AC, 50 Hz
Silent Consumption	<0.5W (DC) <0.6W (AC)
Battery Life (DC)	2 years (avg. 300 uses per day)
Detection Zone	70 cm (adjustable)
Dia. Of Inlet/Outlet Pipe	(DN15)G1/2"
Water Pressure	0.05 MPa – 0.6 MPa
Flow Rate	0.2 L/min – 0.4 L/min
Panel	Stainless Steel 304

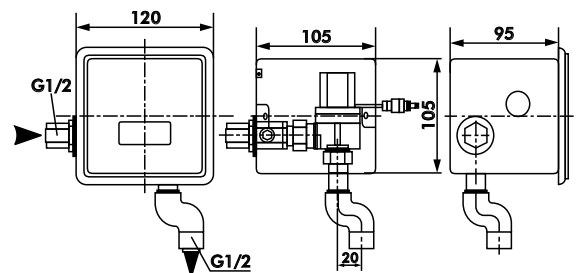
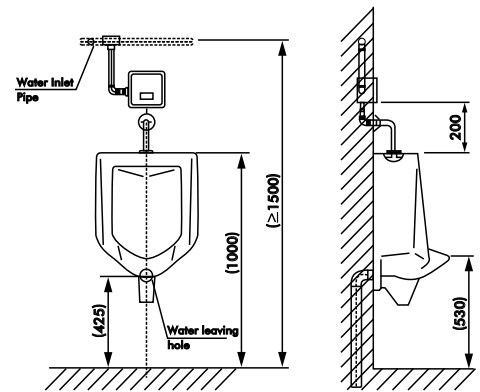

Automate to Protect



Toshi Automatic Systems Pvt. Ltd.

D-132-133/2, Bulandshahr Industrial Area, Ghaziabad - 201009, U.P., India

+91-9711-186-186

info@toshiautomatic.com

facebook

LinkedIn

YouTube

WhatsApp

www.toshiautomatic.com